

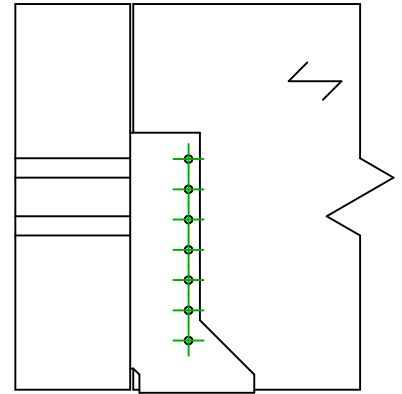

Art. Nr. =	BSIN440	
Fastgørelsesmidler =	Træ til træ	Bjælke til bjælke
Type af fastgørelse =	Fuld udsømning	

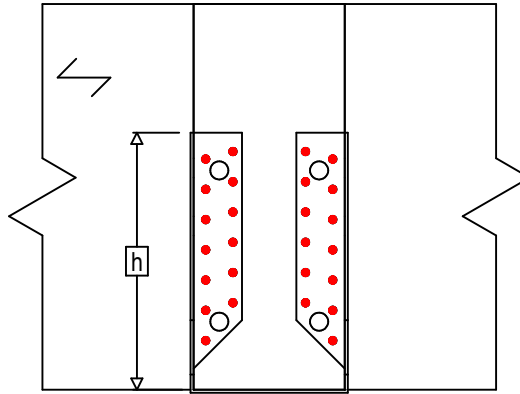

$$h = (440 - L) / 2$$

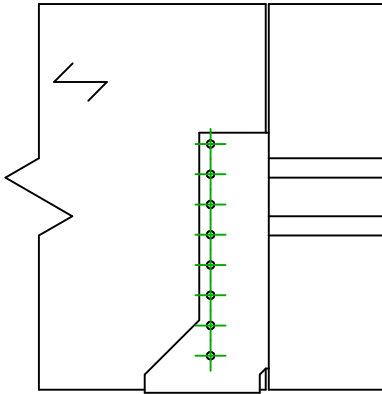
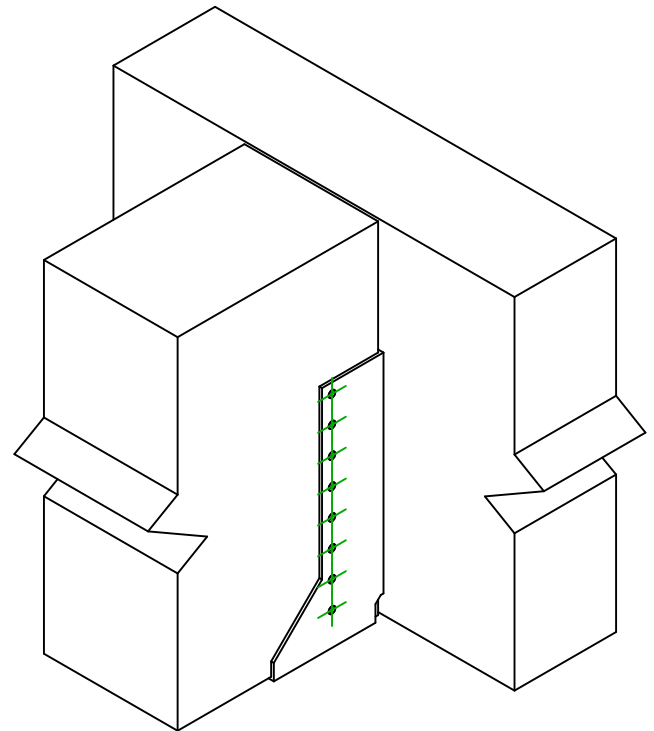

Fastgørelsesmidler i hovedbjælke	Symbol	Fastgørelsesmidler	Fastgørelsesmidler		Antal		
		CNA		CNA4.0X35 / CNA4.0X50		26	
CSA			CSA5.0X35 / CSA5.0X40				
-		-	-				
Fastgørelsesmidler i sekundær bjælke	Symbol	Fastgørelsesmidler	L < 64mm	L > 64mm	Antal		
		CNA		CNA4.0X35		CNA4.0X50	15
		CSA		CSA5.0X35		CSA5.0X40	